

STAINLESS STEEL HI PRESSURE FILTERS

**INSTALLATION,
SERVICE AND
MAINTENANCE
MANUAL
AND SAFETY
INSTRUCTIONS**

FZX011



EN



PASSION T PERFORM



TABLE OF CONTENTS

| | Pagina |
|--|--------|
| 1. Description | 2 |
| 2. General warnings | 2 |
| 3. Tools | 2 |
| 4. Handling | 3 |
| 5. Dimensional drawings | 4 |
| 6. Installation | 6 |
| 7. Commissioning | 6 |
| 8. Standard maintenance | 8 |
| 8.1 Filter element replacement | 8 |
| 9. Special maintenance | 9 |
| 9.1 Seals replacement | 9 |
| 10. Instructions for use in explosive atmospheres | 10 |
| 11. Regulations | 10 |
| 12. Spare parts list | 11 |
| 13. Ordering code | 12 |
| 13.1 Filter / Housing / Bowl | 12 |
| 13.2 Filter element | 13 |
| 14. Troubleshooting | 14 |
| 14.1 Misuse of the product | 14 |
| 14.2 Leaks of working fluid | 14 |



Please scan the QR codes to get updated electronic version of the related document.



1. Description

The hydraulic filters are components used to remove the contaminants from the hydraulic fluids used in the hydraulic systems. FZX filters are made of stainless steel to meet extreme conditions and corrosive environments, with maximum pressure up to 1000 bar, flow rate up to 10 l/min.

2. General warnings

- Before the installation, use or maintenance of the filter carefully read the manual
- The system and the filter are pressurised! Be sure the system is at ambient pressure before starting any activity
- The fluid temperature inside the system and the filter can cause injuries to personnel or create a hazardous environment
- Any activity must be carried out by trained and certified specialists, they must use the correct protective equipment
- Any activity must be carried out using the correct tool
- Any activity must be carried out in accordance with the laws in force in the country where the system is in operation
- The data shown onto the nameplate must be complete and legible during the whole filter working life
- Connect the filter with an anti-loosening system and regularly check the condition of the connection
- The declared performances and the safety of the product are only guaranteed when MP Filtri original spare parts are used
- Warranty is only effective if MP Filtri original spare parts are used.

3. Tools

| FZX011 | TOOL | TIGHTENING TORQUE |
|------------------------------|------------------------|-------------------|
| Bowl | Wrench A/F 36 | 50 N·m |
| Connection G 1/4 | Wrench A/F 19 | Max 35 N·m |
| Connection 1/4-18 NPT | Wrench A/F 14 | Max 28 N·m |
| Connection G 1/2 | Wrench A/F 27 | Max 65 N·m |
| Connection 1/2-14 NPT | Wrench A/F 24 | Max 54 N·m |
| Fastening screws M8 | Socket wrench A/F 13 | 25 N·m |
| Fastening screws 5/16-18 UNC | Socket wrench A/F 1/2" | 25 N·m |

4. Handling

- The unit is shipped in a cardboard box with dimensions depending on the order
- The handling must be carried out in accordance with the laws in force in the country of use of the product
- Handle the product with care, avoid impacts
- Store in a dry and frost-free room
- The unit should be stored in a suitable location away from the production area when not in use.
The unit should be stored with the caps provided on the ports and the bowl's protective net, if present.
This location should not impede any other production or personnel.

Please refer to the following Weight table:

| SERIES AND SIZE | WEIGHTS [kg] | |
|--------------------|--------------|-----|
| | Length | |
| FZX011 | | 6.5 |

5. Dimensional drawings

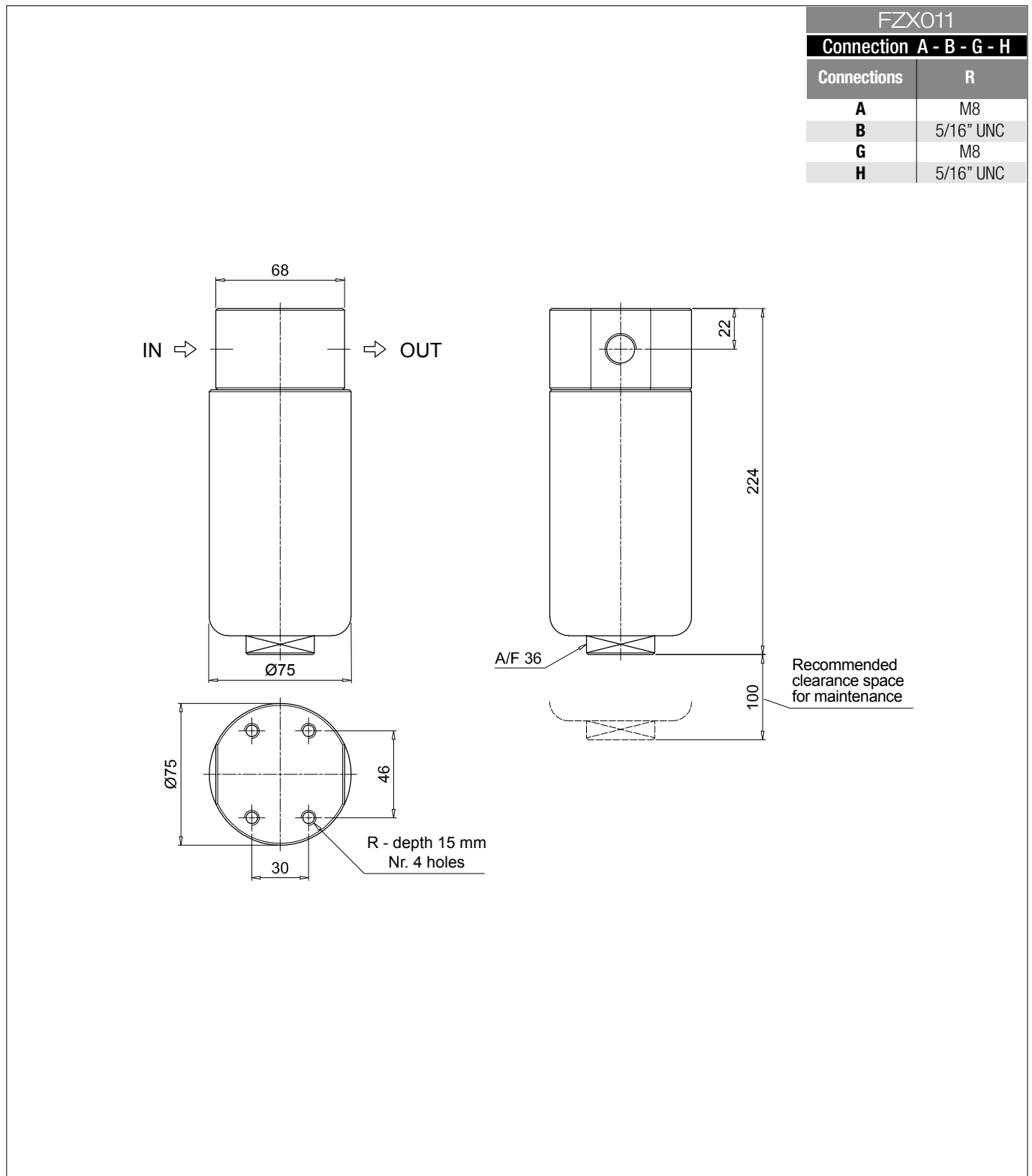

FZX011

| FZX011 | |
|------------------|----|
| Connection M - L | |
| Connections | R |
| M | M8 |
| L | M8 |

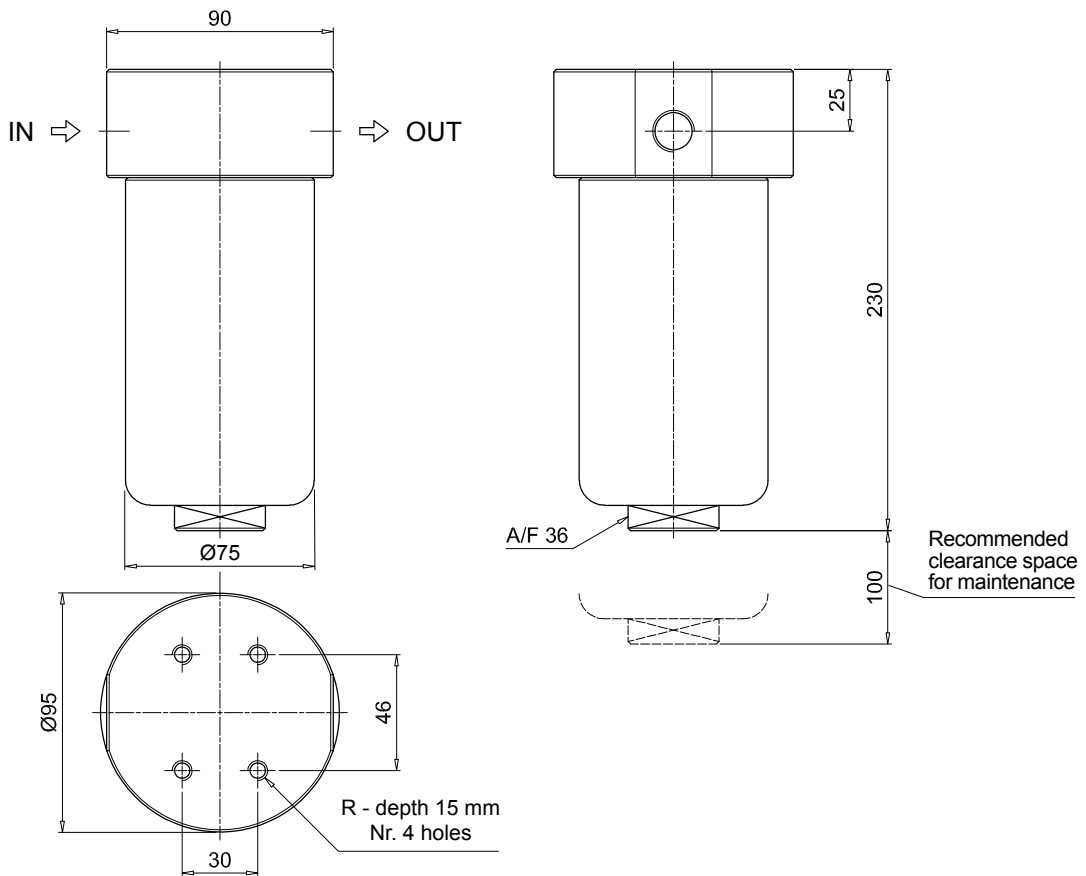

6. Installation

- Check that the system working pressure does not exceed the maximum working pressure of the filter.
The maximum working pressure of the filter is shown on the laser marking on the head
- Check that the filter is compatible with the fluid used in the system
- Remove the plastic plugs from the inlet, the outlet and the indicator connection
- Check that the correct filter elements are fitted into the filter
- Check the flow direction (the flow is indicated by two arrows on the filter body)
- Fasten the filter to the bracket with the correct bolts. Be sure to fit the filter without any tension stress
- Check that there is appropriate clearance for maintenance and the filter elements replacement.
Correct operation is only guaranteed if the filter is installed in a vertical orientation with the filter housing at the top
- Connect the filter to the hydraulic system, using the appropriate hydraulic fittings.

7. Commissioning

- Switch on the hydraulic system
- Check the filter is free of leaks
- Check the filter for leaks at the maximum working conditions (pressure, temperature ...)
- Check the filter does not cause excessive pressure drop.

FZX011

8. Standard maintenance

8.1 FILTER ELEMENT REPLACEMENT

The clogging indicator monitors the conditions of the filter element in the working section of the filter. The alarm signal shown by the differential indicator during the normal working conditions (pressure, temperatures ...) means that the filter element needs to be replaced.

- Check the availability of the right spare filter element by comparing the part number shown on the element with that shown on the filter name plate or spare parts list.
- For the disassembly and the assembly of the parts, please refer to the tools table in paragraph 3
- Switch off the system
- (Fig. 1) Unscrew the filter bowl after placing a vessel to collect the operating fluid
- (Fig. 2) Empty the operating fluid from the bowl into the collection vessel
- (Fig. 3) Pull the filter element out.
- Clean the cavity in the housing, the tap and the bowl. Check them for damage.
- Check the condition of the bowl seals and, if necessary, replace them referring to the "Special maintenance" paragraph.
- (Fig. 4) Lubricate with the operating fluid the filter element O-ring, the housing tap and cavity, then fit the filter element on the tap. Pay attention not to damage the O-ring seal
- (Fig. 5) Lubricate the thread and the O-ring of the bowl, then screw the bowl in referring to the tightening torque table in paragraph 3
- Switch on the system and check the filter for leaks at the maximum working conditions (pressure, temperature...).
- Dispose of the replaced parts and the collected fluid in accordance with the laws in force in the country of use of the product.

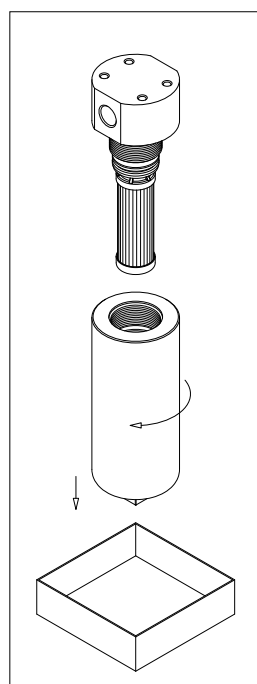

fig. 1

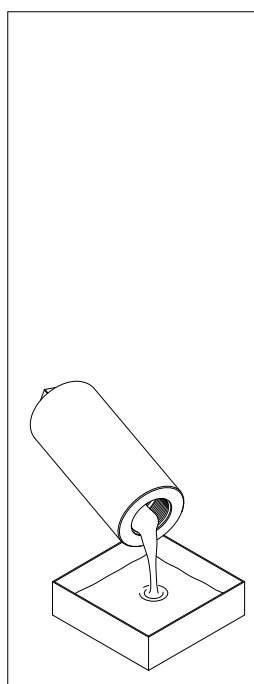

fig. 2

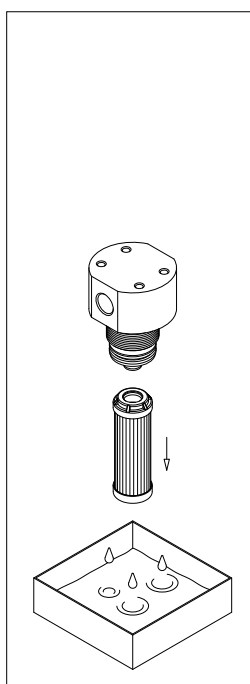

fig. 3

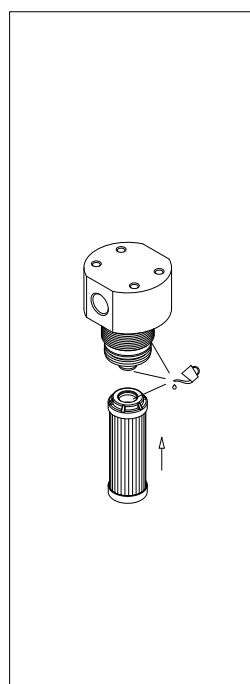

fig. 4

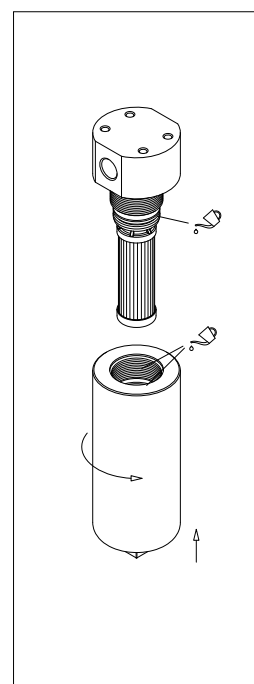

fig. 5

9. Special maintenance

9.1 SEALS REPLACEMENT

- Check the availability of the right spare parts by comparing the part numbers shown on them with that shown on the filter name plate or spare parts list
- For the disassembly and the assembly of the parts, please refer to the tools table in paragraph 3
- Switch off the system
- (Fig. 6) Unscrew the filter bowl after placing a vessel to collect the operating fluid
- (Fig. 7) Empty the operating fluid from the bowl into the collection vessel
- (Fig. 8) Pull the filter element out
- Remove all the seal from the bowl and the filter element and prepare the spare parts referring to the list in paragraph 12
- Clean the cavity in the housing, the tap and the bowl. Check them for damage
- (Fig. 9) Fit #1: the anti-extrusion ring and #2: the O-ring in the bowl groove, insert the O-ring in the filter element cap
- (Fig. 10) Lubricate with the operating fluid the filter element O-ring, the housing tap and cavity, then fit the filter element on the tap. Pay attention not to damage the O-ring seal
- (Fig.11) Lubricate the thread and the O-ring of the bowl, then screw the bowl in referring to the tightening torque table in paragraph 3
- Switch on the system and check the filter for leaks at the maximum working conditions (pressure, temperature...).
- Dispose of the replaced parts and the collected fluid in accordance with the laws in force in the country of use of the product.

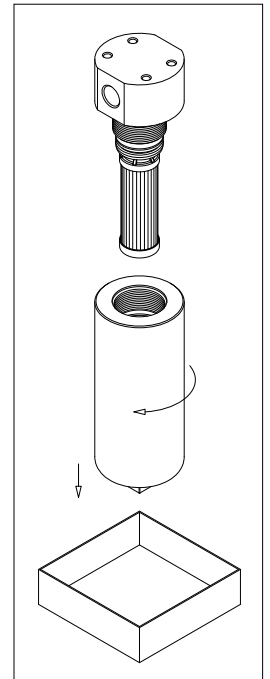

fig. 6

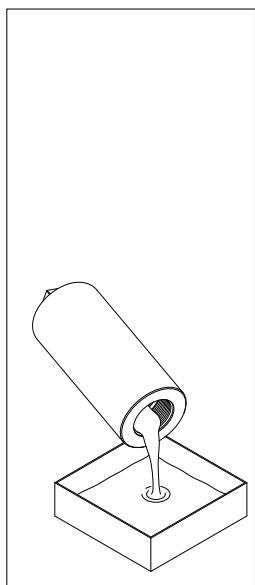

fig. 7

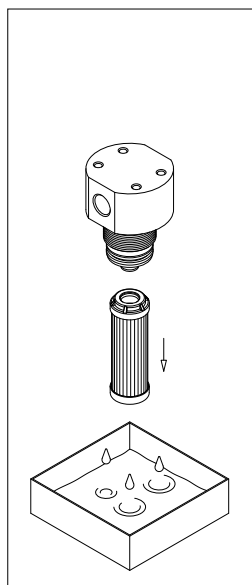

fig. 8

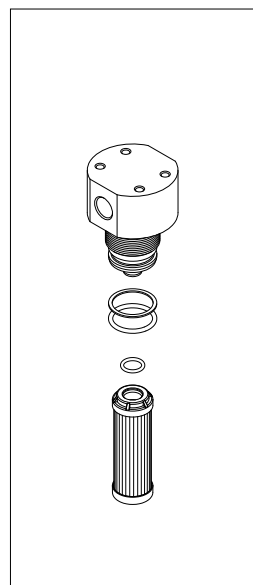

fig. 9

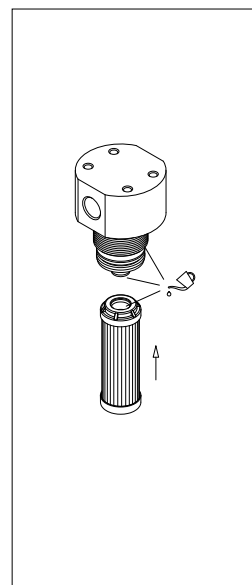

fig. 10

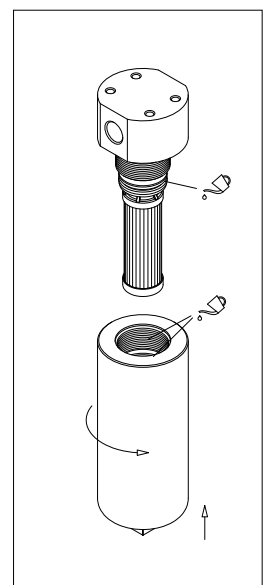

fig. 11

10. Instructions for use in explosive atmospheres

Hydraulic filters should be installed in applications in which special safety measures are required to prevent the triggering of explosive atmospheres, such as use in environments classified according to directive 1999/92/CE (ATEX) or the use of flammable fluids.

Conditions like the use of low conductivity fluids, which could cause electrostatic discharges, or installation near hot components, which could cause surfaces heating, could alter the safety of the filters.

MP FILTRI has carried out a voluntary certification of a part of the product range in compliance with directive 2014/34/EU, in order to guarantee an appropriate degree of safety in these particular conditions.

The content of the certification and the relative marking make them suitable for use in environments classified in accordance with directive 1999/92/CE (ATEX - ZONE 2).

11. Regulations

Hydraulic filters are not machines, but simple components.

Hydraulic filters are excluded from the scope of the Machinery Directive 2006/42/EC, they don't need the CE mark.

Hydraulic filters are designed to be fitted within a hydraulic system designed in accordance with the Machinery Directive 2006/42/EC.

Hydraulic filters are pressurized components. The maximum working pressure PS is over 0.5 bar, so they are subject to the Directive 2014/68/EU (PED).

FZX filters are designed and manufactured for fluids included into the Group 2 defined by the Directive 2014/68/EU.

FZX filters do not need the CE marking in accordance with the Directive 2014/68/UE Article 4, Section 3.

FZX filters do not contain any substance of very high concern (SVHC) in percentage higher than 0.1% in accordance with the Regulation (EC) No 1907/2006 (REACH).

FZX filters are designed and manufactured in accordance with the Commission Delegated Directive (EU) 2015/863 (RoHS).

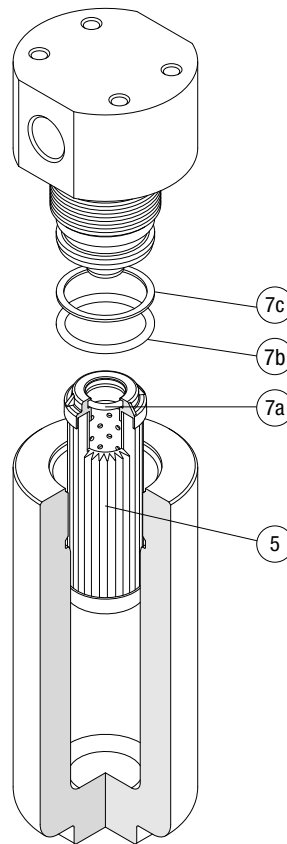
12. Spare parts list

| Item | Quantity | Description | Designation / Ordering code | | |
|------|----------|--------------------------|--|----------|----------|
| 1 | 1 | Complete filter | See "Ordering Code" table | | |
| 3 | 1 | Housing | | | |
| 4 | 1 | Bowl assembly | | | |
| 5 | 1 | Filter element | | | |
| 7 | 1 | Seals kit | NBR | FPM | MFQ |
| | | | 02050643 | 02050644 | 02050646 |
| 7a | 1 | Filter element seal | O-Ring 121 - di = 15.88 - d ₂ = 2.62 | | |
| 7b | 1 | Bowl seal | O-Ring 4131 - di = 32.93 - d ₂ = 3.53 | | |
| 7c | 1 | Bowl anti-extrusion ring | SR219 | | |

13. Ordering code

13.1 FILTER / HOUSING / BOWL

| FILTER / HOUSING / BOWL | | | | | | | | | | | |
|---|---|----------|--------|---|---|---|---|---|-----|------------------------|-----|
| Filter series and size | | Filter: | FZX011 | 3 | S | V | B | 1 | A03 | U | P01 |
| FZX011 | Filter / housing | Housing: | FZX011 | | S | V | B | 1 | | | P01 |
| HZX011 | Bowl assembly | Bowl: | HZX011 | 3 | | V | | | A03 | U | P01 |
| Filter length | | | | | | | | | | | |
| | 3 | | | | | | | | | | |
| Valves | | | | | | | | | | | |
| | S Without bypass | | | | | | | | | | |
| Seals | | | | | | | | | | | |
| | A NBR | | | | | | | | | | |
| | V FPM | | | | | | | | | | |
| | F MFQ | | | | | | | | | | |
| Connections | | | | | | | | | | | |
| | 700 bar | | | | | | | | | | |
| | A G 1/4" | | | | | | | | | | |
| | B 1/4" NPT | | | | | | | | | | |
| | G G 1/2" | | | | | | | | | | |
| | H 1/2" NPT" | | | | | | | | | | |
| | Autoclave 1000 bar | | | | | | | | | | |
| | M 9/16" - 18 UNF | | | | | | | | | | |
| | L 3/4" - 14 NPS | | | | | | | | | | |
| Connection for differential indicators | | | | | | | | | | | |
| | 1 Without connection | | | | | | | | | | |
| Filtration rating (filter media) | | | | | | | | | | | |
| | A03 Inorganic microfiber | 3 | µm | | | | | | | | |
| | A06 Inorganic microfiber | 6 | µm | | | | | | | | |
| | A10 Inorganic microfiber | 10 | µm | | | | | | | | |
| | A16 Inorganic microfiber | 16 | µm | | | | | | | | |
| | A25 Inorganic microfiber | 25 | µm | | | | | | | | |
| Element Δp | | | | | | | | | | | |
| | H 210 bar | | | | | | | | | | |
| | U 210 bar, stainless steel filter element | | | | | | | | | | |
| | | | | | | | | | | Execution | |
| | | | | | | | | | | P01 MP Filtri standard | |
| | | | | | | | | | | Pxx Customized | |

FZX011

13.2 FILTER ELEMENT

| FILTER ELEMENT | |
|--|---|
| Element series and size HP011 | Example: HP011 3 A03 V U P01 |
| Element length 3 | |
| Filtration rating (filter media) A03 Inorganic microfiber 3 μm A06 Inorganic microfiber 6 μm A10 Inorganic microfiber 10 μm A16 Inorganic microfiber 16 μm A25 Inorganic microfiber 25 μm | |
| Seals A NBR V FPM F MFQ | |
| Element Δp H 210 bar U 210 bar, stainless steel filter element | |
| | Execution P01 MP Filtri standard Pxx Customized |

14. Troubleshooting

14.1 MISUSE OF THE PRODUCT

This product should be connected to a hydraulic line; this must not exceed upper pressure limit of the product. This product should follow all standard operating procedures previously set at the operating location as well as the procedures required by the manufacturer.

Over-tighten of test points/hoses can damage threads causing the unit to fail.

The product is designed with no components in motion.

14.2 LEAKS OF WORKING FLUID

Leaks from the connections with normal tightening may indicate seal damage during the warehousing process, fluid incompatibility, or unsuitable work conditions.

All data, details and words contained in this publication are provided for use by technically qualified personnel at their discretion, without warranty of any kind.

MP Filtri reserves the right to make modifications to the models and versions of the described products at any time for both technical and/or commercial reasons.

For updated information please visit our website: www.mpfiltri.com

The colors and the pictures of the products are purely indicative.

Any reproduction, partial or total, of this document is strictly forbidden.

All rights are strictly reserved

WORLDWIDE NETWORK

CANADA ♦ CHINA ♦ FRANCE ♦ GERMANY ♦ INDIA ♦ SINGAPORE
UNITED ARAB EMIRATES ♦ UNITED KINGDOM ♦ USA



PASSION  PERFORM

in @ y f



mpfiltri.com